

# Study on Three-Phase Four-Wire UPQC device for Power Quality Improvement

<sup>1</sup>Sumaya Banu, <sup>2</sup>Dr. Sidheswar Prasad

<sup>1</sup>M.Tech, <sup>2</sup>Professor

<sup>1</sup>Department of Electricals and Electronics ,  
<sup>1</sup>The Oxford College of Engineering, Bangalore, India

**Abstract** - The unified power quality conditioner [UPQC] is one of the advanced forms of custom devices, which consists of a hybrid series filter for compensating the voltage disturbances and a shunt active power filter for eliminating current distortions. This custom power device is mainly employed to overcome the power quality [PQ] problems by improving the quality of supply voltage and its waveforms, and to minimize present harmonic contents in nonlinear load currents in power distribution systems. In this paper, the configuration of UPQC, the designs of various components of UPQC, such as series and shunt active filter VSI parameters, the controllers, etc have been designed for simulation studies against nonlinear loads using MATLAB/ Simulink environments. The simulation studies on both conventional and modified topology of UPQC are presented, which have been carried out by considering a case example of voltage sag, swell, interruption, and harmonic distortions. From the simulation results on conventional and modified UPQC topology, it can be concluded that the modified topology has less average switching frequency, less THDs in load voltages and currents from the source. It has been also observed that the modified UPQC system gives reduced dc-link voltage than the conventional UPQC topology.

**Index Terms**—Unified Power Quality Conditioner (UPQC), Distribution Static Compensator (DSTATCOM), Dynamic Voltage Restorer (DVR), Voltage Source Inverter (VSI), Total Harmonic Distortion (THD), dc-link Voltage, average switching frequency.

## I. INTRODUCTION

In recent years, Power engineers are concerned with overall quality of the supply of electrical power. Power Quality [PQ] phenomena include all situations in which the supply voltage (voltage quality) or load current (current quality) waveforms deviate from the sinusoidal waveform at rated frequency with amplitude corresponding to peak value in all the phases for any three-phase supply system. The term Power Quality [PQ] has gained significant importance, especially in electrical power distribution system. As per the International standards, the term power quality can be defined as the physical characteristics of the electrical supply provided under normal operating condition that do not disrupt or disturb the user's processes.

With the advancement of power electronics and digital control technology, the renewable energy sources are increasingly being connected to power distribution systems. On the other hand, the nonlinear loads and unbalanced loads have degraded the power quality [PQ] in the power distribution network. Voltage sags or swells and harmonics are the most frequently occurring phenomena, which are affecting most commercial and industrial customers and creating PQ problems. Custom power devices have been proposed for enhancing the quality and reliability of supply. The UPQC is one of the power electronics based custom power device, which is used to deliver power at desired standards and specifications. An ideal UPQC comprises of two core parts series connected Active Power Filter [APF] and shunt connected APF, connected in a back-to-back configuration sharing a common dc-link through an energy storage system consists of dc-capacitor. The major objective of series APF is to compensate for voltage imbalances, voltage distortion and harmonics in the line as well as to provide improved voltage regulation at utility. Whereas the function of shunt APF is to regulate current and compensate reactive and negative sequence current at the load terminals, and to reduce the dc capacitor rating by regulating the DC link voltage between the two APFs. Thus, the UPQC simultaneously acts as shunt and series active power filters. The series part of the UPQC is known as Dynamic Voltage Restorer [DVR]. It is used to maintain balanced, distortion free nominal voltage at the load. The shunt part of the UPQC is known as Distribution Static Compensator [DSTATCOM], and it is used to compensate load reactive power, harmonics and balance the load currents thereby making the source current balanced and distortion free power supply nearer to unity power factor. Conventional UPQC is constituted of two Voltage Source Converters [VSC], an injection transformer and a common DC link. The presence of injection transformer can create problems like offset due to energization of transformers, increased losses in transformer windings and high cost of the system. Thus there is a need for a better injecting device.

The disturbances in voltage such as harmonics, sags, swells etc. may cause the tripping of sensitive electronic equipment which can lead to disastrous consequences in industrial plants, such as, unexpected results or a termination of the whole production line. These events are common in industrial sectors and cause high economical damage. In the above scenario, it is the source that disturbs the load or sensitive equipment. To avoid heavy economical losses, the industrial customers often install mitigation devices/ equipments to protect their own plants from such kind of disturbances. One of the most effective solutions to power quality issues in the distribution side is the installation of Unified Power Quality Conditioner. UPQC is supporting for alleviating all the voltage and current related problems.

In this paper, the UPQC device for application with non-stiff source is proposed. The proposed (modified) topology enables UPQC to have a reduced dc-link voltage without compromising its compensation capability. This proposed topology also helps to match the dc-link voltage requirement of the shunt active filter, and the system neutral is connected to the negative terminal of the dc-link voltage to avoid the requirement of the fourth leg in the Voltage Source Inverter (VSI) of the shunt active filter. The average switching frequency of the switches in the VSI also reduces, consequently the switching losses in the inverter reduce.

**II. CONVENTIONAL AND MODIFIED VSI BASED UPQC COMPENSATED DISTRIBUTION SYSTEM**

The power circuit of conventional neutral-clamped VSI topology-based UPQC is shown in Fig. 1. Even though this topology requires two dc storage devices, each leg of the VSI can be controlled independently, and tracking is smooth with less number of switches when compared to other VSI topologies.

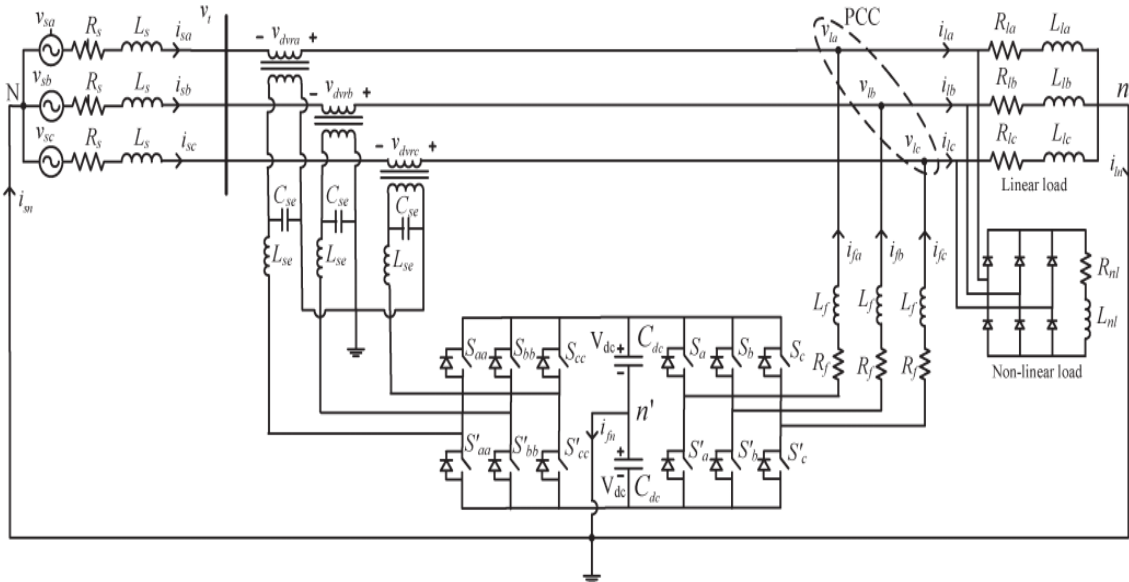

Figure 1. Conventional VSI based UPQC Compensated Distribution system

In the Figure 1  $V_{sa}$ ,  $V_{sb}$  and  $V_{sc}$  are source voltages of phases a, b, and c respectively. Similarly,  $V_{ta}$ ,  $V_{tb}$ , and  $V_{tc}$  are terminal voltages. The voltages  $V_{dvra}$ ,  $V_{dvrb}$ , and  $V_{dvrc}$  are injected by the series active filter. The three-phase source currents are represented by  $i_{sa}$ ,  $i_{sb}$ , and  $i_{sc}$ , load currents are represented by  $i_{la}$ ,  $i_{lb}$ , and  $i_{lc}$ . The shunt active filter currents are denoted by  $i_{fa}$ ,  $i_{fb}$ ,  $i_{fc}$ , and  $i_{in}$  represents the current in the neutral leg.  $L_s$  and  $R_s$  represent the feeder inductance and resistance, respectively.

The interfacing inductance and resistance of the shunt active filter are represented by  $L_f$  and  $R_f$ , respectively, and the interfacing inductance and filter capacitor of the series active filter are represented by  $L_{se}$  and  $C_{se}$  respectively. The load constituted of both linear and nonlinear loads. The dc-link capacitors and voltages across them are represented by  $C_{dc1} = C_{dc2} = C_{dc}$  and  $V_{dc1} = V_{dc2} = V_{dc}$ , respectively, and the total dc-link voltage is represented by  $V_{dbus}(V_{dc1} + V_{dc2} = 2V_{dc})$ . In this conventional topology, the voltage across each common dc-link capacitor is chosen as 1.6 times the peak value of the source voltages.

The modified VSI based UPQC compensated distribution system is as shown in Fig. 2. In this topology, the system neutral has been connected to the negative terminal of the dc bus along with the capacitor  $C_f$  in series with the interfacing inductance of the shunt active filter. The passive capacitor  $C_f$  has the capability to supply a part of the reactive power required by the load, and the active filter will compensate the balance reactive power and the harmonics present in the load. The addition of capacitor in series with the interfacing inductor of the shunt active filter will significantly reduce the dc-link voltage requirement and consequently reduces the average switching frequency of the switches. The reduction in the dc-link voltage requirement of the shunt active filter enables us to match the dc-link voltage requirement with the series active filter. This topology avoids the over rating of the series active filter of the UPQC compensation system. The design of the series capacitor  $C_f$  and the other VSI parameters have significant effect on the performance of the compensator. This topology uses a single dc capacitor unlike the neutral-clamped topology and consequently avoids the need of balancing the dc-link voltages.

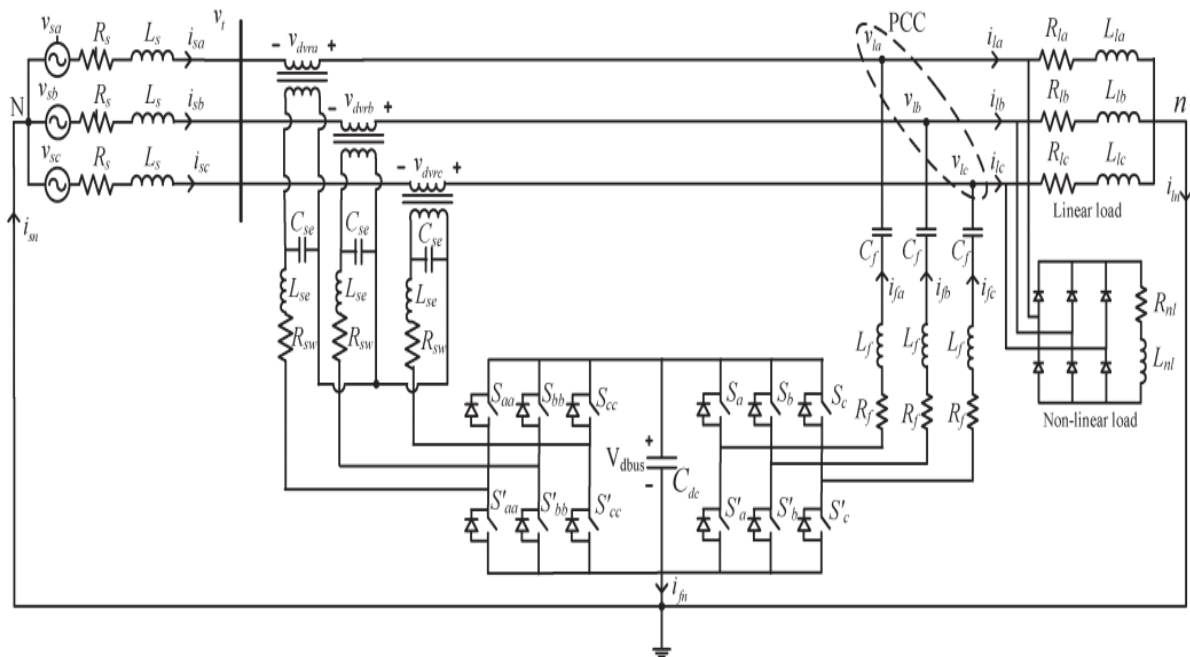

Figure 2. Modified VSI based UPQC compensated distribution system

### III. DESIGN OF VSI PARAMETERS

The parameters of the VSI need to be designed carefully for better tracking performance. The important parameters that need to be taken into consideration while designing conventional VSI are  $V_{dc}$ ,  $C_{dc}$ ,  $L_f$ ,  $L_{se}$ ,  $C_{se}$ , and switching frequency ( $f_{sw}$ ). The design details of the VSI parameters for the shunt and series active filter are given in. Based on the following equations, the parameters of the VSIs are chosen for study.

#### Design of shunt active filter VSI parameters

Consider the active filter is connected to an X kVA system and deals with 0.5X kVA and 2X kVA handling capability under transient conditions for n cycles. During transient, with an increase in system kVA load, the voltage across each dc link capacitor ( $V_{dc}$ ) decreases and vice versa. Allowing a maximum of 25% variation in  $V_{dc}$  during transient, the differential energy ( $\Delta E_c$ ) across  $C_{dc}$  is given by

$$\Delta E_c = C_{dc} [(1.125V_{dc})^2 - (0.875V_{dc})^2] / 2. \tag{1}$$

The change in system energy ( $\Delta E_s$ ) for a load change from 2X kVA to 0.5X kVA is

$$\Delta E_s = (2X - X/2)nT. \tag{2}$$

Equating (1) and (2), the dc-link capacitor value is given by

$$C_{dc} = [2(2X - X/2)nT] / [(1.125V_{dc})^2 - (0.875V_{dc})^2] \tag{3}$$

where,  $V_m$  is the peak value of the source voltage, X is the kVA rating of the system, n is number of cycles, and T time period of each cycle. An empirical study has been carried out for various values of interfacing inductance values with the variation of the dc-link voltage in [31], with  $V_{dc} = mV_m$ , and it is found that  $m = 1.6$  gives fairly good switching performance of the VSI. The approximate relationship between m and minimum ( $f_{swmin}$ ), maximum switching frequency ( $f_{swmax}$ ) is obtained by analysis of the VSI in , and this is given below. For switching frequency variation approximately from 6 kHz to 10 kHz, the value of m is 1.58, which is taken as 1.6 in the study

$$m = 1 / \sqrt{(1 - f_{swmin}/f_{swmax})} \tag{4}$$

Based on this, the shunt interfacing inductance has been derived taking into consideration of the maximum switching frequency and is given below

$$L_f = mV_m / 4h_1f_{swmax} \tag{5}$$

where

$$h_1 = \sqrt{(k_1/k_2)(2m^2 - 1)/4m^2} f_{swmax} \tag{6}$$

where, h1 is the hysteresis band limit, k1 and k2 are proportionality constants.

### Design of Series Active Filter VSI Parameters

In order to make the series active filter system a first-order system, a resistor is added in series with the filter capacitor, referred as switching band resistor ( $R_{sw}$ ). The rms value of the capacitor current can be expressed as  $I_{se} = \sqrt{I_{inv}^2 - I_1^2}$ .  $I_{inv}$  is the series inverter current rating and  $I_1$  is the load current. The capacitor branch current is divided into two components, a fundamental current  $I_{se1}$ , corresponding to the fundamental reference voltage ( $V_{ref1}$ ) and a switching frequency current  $I_{sw}$ , corresponding to the band voltage ( $V_{sw}$ ).

The DVR voltage and the current of the capacitor are given by

$$\begin{aligned} V_{dvr} &= \sqrt{V_{ref1}^2 + V_{sw}^2} \\ I_{se} &= \sqrt{I_{se1}^2 + I_{sw}^2} \\ V_{sw} &= I_{sw} R_{sw} = h_2 / \sqrt{3} \\ V_{ref1} &= I_{se1} X_{se1} = I_{se1} / 2\pi f_1 C_{se} \end{aligned} \quad (7)$$

where  $h_2$  is the hysteresis band voltage. The resistance ( $R_{sw}$ ) and the capacitance ( $C_{se}$ ) values are expressed in terms of band voltage and rated reference voltage ( $V_{ref1}$ ), respectively, and are given by

$$\begin{aligned} R_{sw} &= h_2 / I_{sw} \sqrt{3} \\ C_{se} &= I_{se1} / V_{ref1} 2\pi f_1 \end{aligned} \quad (8)$$

The interfacing inductor  $L_{se}$  has been designed based on the switching frequency of the series active filter and is given by

$$L_{se} = (V_{bus}) R_{sw} / 4f_{sw} h_2 \quad (9)$$

where  $V_{bus}$  is the total dc-link voltage across both the dc-link capacitors. A design example is illustrated for a rated voltage of 230V line to neutral and the dc-link voltage reference ( $V_{dref}$ ) of the conventional VSI topology has been taken as 1.6 Vm for each capacitor. The hysteresis band ( $h_1$ ) is taken as 0.5 A. From (5), the interfacing inductance ( $L_f$ ) is computed to be 26 mH. The base kVA rating of the system is taken as 5kVA. Using (3),  $C_{dc}$  is computed and found to be 2200  $\mu$ F. The rated series VSI voltage is chosen as 50% of the rated voltage, i.e., the maximum injection capacity of the series active filter is 115 V. The hysteresis band ( $h_2$ ) for series active filter is taken as 3% of the rated voltage, i.e., 6.9 V. The maximum switching frequency of the IGBT-based inverter is taken as 10 kHz. The series active filter current rating is chosen as 8 A and the rated load current as 7 A. Interfacing inductance  $L_{se}$  are calculated to be 80  $\mu$ F, 1.5  $\Omega$ , and 5mH, respectively. The system parameters are given in Table I for the conventional VSI topology.

### Design of $C_f$ for the Proposed VSI Topology

The design of the  $C_f$  depends upon the value to which the dc-link voltage is reduced. In general, loads with only nonlinear components of currents are very rare, and most of the electrical loads are combination of the linear inductive and nonlinear loads. Under these conditions, the proposed topology will work efficiently. The design of the value of  $C_f$  is carried out at the maximum load current, i.e., with the minimum load impedance to ensure that the designed  $C_f$  will perform satisfactorily at all other loading conditions. If  $S_{max}$  is the maximum kVA rating of a system and  $V_{base}$  is the base voltage of the system, then the minimum impedance in the system is given as

$$Z_{min} = V_{base}^2 / S_{max} = |R_l + jX_l| \text{ (say)}. \quad (10)$$

In order to achieve the unity power factor, the shunt active filter current needs to supply the required reactive component of the load current, i.e., the fundamental imaginary part of the filter current should be equal to the imaginary part of the load current. The filter current and load current in a particular phase are given below

$$I_{filter} = V_{inv1} - V_{l1} / (R_f + j(X_{lf} - X_{cf})) \quad (11)$$

$$I_{load} = V_{l1} R_l + jX_l \quad (12)$$

where,  $X_{lf} = 2\pi f L_f$ ,  $X_l = 2\pi f L_l$ ,  $X_{cf} = 1/2\pi f C_f$ , and  $f$  is the supply frequency of fundamental voltage. Neglecting the interfacing resistance and equating the imaginary parts of the above equations gives (13)

$$V_{l1} X_{lf} / (R_{l1} + X_{l1}) = (V_{inv1} - V_{l1}) / ((X_{lf} - X_{cf})^2) (X_{lf} - X_{cf}) \quad (13)$$

where,  $V_{inv1}$  and  $V_{l1}$  are the line to neutral rms voltage of the inverter and the PCC voltage at the fundamental frequency, respectively. The fundamental component of inverter voltage in terms of dc-link voltage is as given below

$$V_{inv1} = 0.612 V_{dc} / 2\sqrt{3} \quad (14)$$

In general, if the filter current ( $I_f$ ) flows from the inverter terminal to the PCC, the voltage at the inverter terminal should be at a higher potential. Due to this reason, in conventional VSI topologies, the dc-link voltage is maintained higher than the voltage at



the PCC. Equation (15) give the KVL along the filter branch for conventional topology and the proposed modified topology, respectively

$$uV_{dc} - v_l = L_f di_f/dt + R_f i_f \tag{15}$$

Where, u attains values of 1 or -1 depending on the switching of the inverter. In (16), the fundamental voltage across the capacitor (vcf1) adds to the inverter terminal voltage (uV<sub>dc</sub>) when the load is inductive in nature. This is because, when the load is inductive in nature, the fundamental of the filter current leads the voltage at the PCC by 90° for reactive power compensation, and thus the fundamental voltage across the capacitor again lags the fundamental filter current by 90°. Therefore, the fundamental voltage across the capacitor will be in phase opposition to the voltage at the PCC. Thus, the fundamental voltage across the capacitor adds to the inverter terminal voltage. This allows us to rate the dc-link voltage at lower value than conventional design. The designer has a choice to choose the value of dc-link voltage to be reduced, such that the LC filter in the active filter leg of each phase offers minimum impedance to the fundamental frequency and higher impedance for switching frequency components. In the modified topology along with the series capacitor in the shunt active filter, the system neutral is connected to the negative terminal of the dc bus capacitor. This will introduce a positive dc voltage component in the inverter output voltage.

This is because, when the top switch is “ON,” +V<sub>dbus</sub> appears at the inverter output, and 0 V appears when the bottom switch is “ON.” Thus, the inverter output voltage will have dc voltage component along with the ac voltage. The dc voltage is blocked by the series capacitor, and thus the voltage across the series capacitor will be having two components, one is the ac component, which will be in phase opposition to the PCC voltage, and the other is the dc component. Whereas, in case of the conventional topology, the inverter output voltage varies between +V<sub>dc</sub> when top switch is “ON” and -V<sub>dc</sub> when the bottom switch “ON.” Similarly, when a four-leg topology is used for shunt active filter with a single dc capacitor, the inverter output voltage varies between +V<sub>dbus</sub> and -V<sub>dbus</sub>. Therefore these topologies does not contain any dc component in the inverter output voltage. The modified topology contains only one dc capacitor as the neutral is directly connected to the negative terminal of the dc bus, thus it avoids the need of balancing of capacitor voltages which is a major disadvantage of the neutral-clamped topology. Since the neutral wire is directly connected to the negative terminal of the dc bus, the necessity of fourth leg in the inverter is avoided.

#### IV. GENERATION OF REFERENCE COMPENSATOR CURRENTS UNDER UNBALANCED AND DISTORTED VOLTAGES

In this work, the load currents are unbalanced and distorted, these currents flow through the feeder impedance and make the voltage at terminal unbalanced and distorted. The series active filter makes the voltages at PCC balanced and sinusoidal. However, the voltages still contain switching frequency components and they contain some distortions. If these terminal voltages are used for generating the shunt filter current references, the shunt algorithm results in erroneous compensation. To remove this limitation of the algorithm, fundamental positive sequence voltages v<sub>+</sub>la1(t), v<sub>+</sub>lb1(t), and v<sub>+</sub>lc1(t) of the PCC voltages are extracted and are used in control algorithm for shunt active filter. The expressions for reference compensator currents are given in (17). In this equation, P<sub>avg</sub> is the average load power, P<sub>loss</sub> denotes the switching losses and ohmic losses in actual compensator, and it is generated using a capacitor voltage PI controller. The term is obtained using a moving average filter of one cycle window of time T in seconds. The term φ is the desired phase angle between the source voltage and current.

$$\begin{aligned} i_{fa}^* &= i_{la} - i_{sa}^* = i_{la} - ((v_{la1}^+ + \gamma(v_{lb1}^+ - v_{lc1}^+))(P_{avg} + P_{loss})/\Delta_1^+ \\ i_{fb}^* &= i_{lb} - i_{sb}^* = i_{lb} - ((v_{lb1}^+ + \gamma(v_{lc1}^+ - v_{la1}^+))(P_{avg} + P_{loss})/\Delta_1^+ \\ i_{fc}^* &= i_{lc} - i_{sc}^* = i_{lc} - ((v_{lc1}^+ + \gamma(v_{la1}^+ - v_{lb1}^+))(P_{avg} + P_{loss})/\Delta_1^+ \end{aligned} \tag{17}$$

where,

$$\Delta = \tan \Phi / \sqrt{3}.$$

The above algorithm gives balanced source currents after compensation irrespective of unbalanced and distorted supply. The reference voltages for series active filter are given as

$$\begin{aligned} v_{dvri}^* &= v_{li}^* - v_{ti} \\ i &= a, b, c \end{aligned} \tag{18}$$

where v<sub>li</sub><sup>\*</sup> represents the desired load voltages in three phases, and v<sub>dvri</sub><sup>\*</sup> represents the reference series active filter voltage.

TABLE 1 SYSTEM PARAMETERS

System Quantities	Values
System voltages	230v (line to neutral), 50 Hz
Feeder impedance	Z <sub>s</sub> =1+j3.141Ω
Linear Load	Z <sub>la</sub> =4+j47.5Ω, Z <sub>lb</sub> =81+j39.6Ω, Z <sub>lc</sub> =31.5+j70.9Ω
Non-linear Load	three-phase full bridge rectifier load feeding R-L load of 150ohm-300mH
Shunt VSI parameters	C <sub>dc</sub> =2200μF, L <sub>f</sub> =26mH, R <sub>f</sub> =1Ω V <sub>dbus</sub> =2*V <sub>dc</sub> =1040v(conventional), V <sub>dbus</sub> =560v(proposed)
Series VSI parameters	C <sub>se</sub> =80μF, L <sub>se</sub> =5mH, R <sub>sw</sub> =1.5Ω
Series interfacing transformer	1:1, 100V and 700 VA



x-time; y-voltage

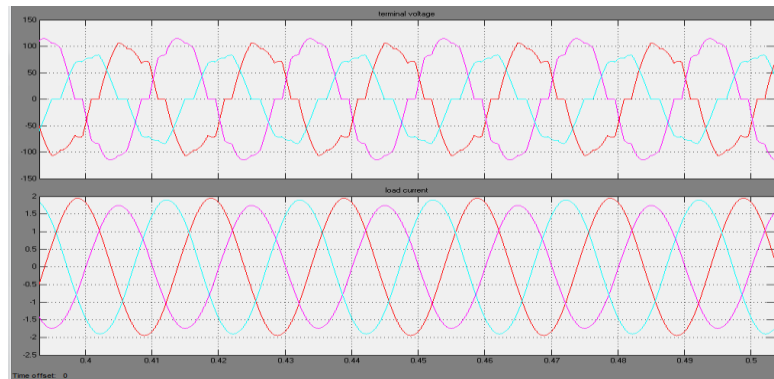

Figure 5 Load current and terminal voltage before compensation

**Simulation model for modified VSI topology-based UPQC compensated system**

The simulation model for modified VSI topology-based UPQC compensated is shown below in Fig. 6. The source voltage and current at bus 2, current injected by shunt VSI to power distribution system at bus 3, and load voltage and current at bus 4 are measured to study the performance of UPQC compensated system.

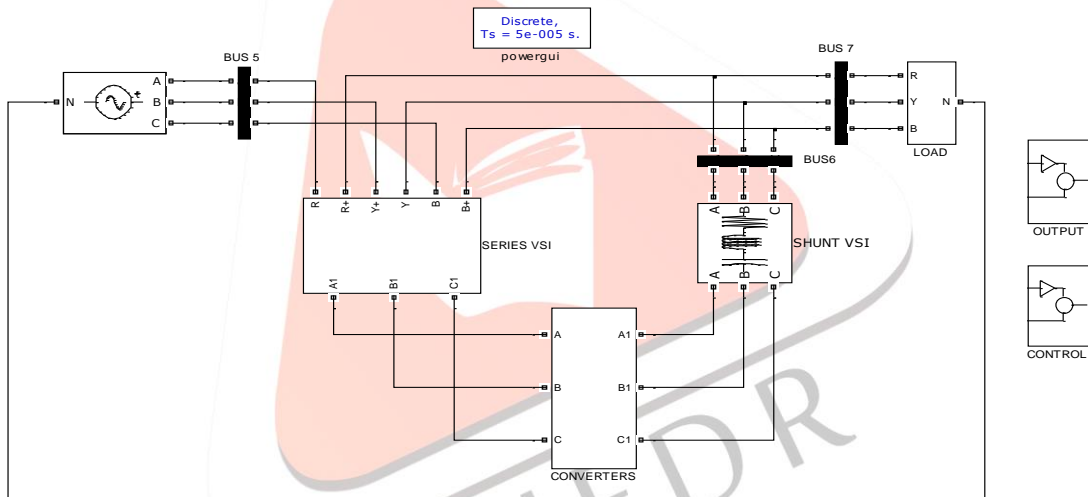
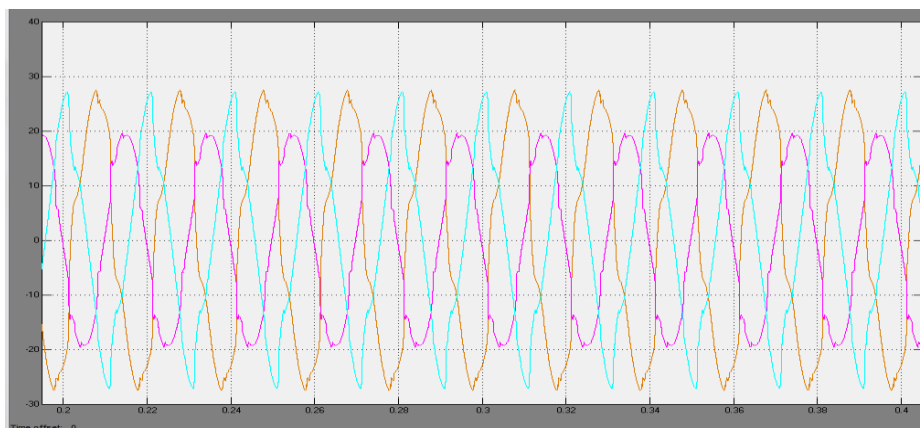

Figure 6 Simulation model for modified VSI topology-based UPQC compensated power distribution system

**Output waveforms with Conventional topology**

x-time; y-voltage



(a)

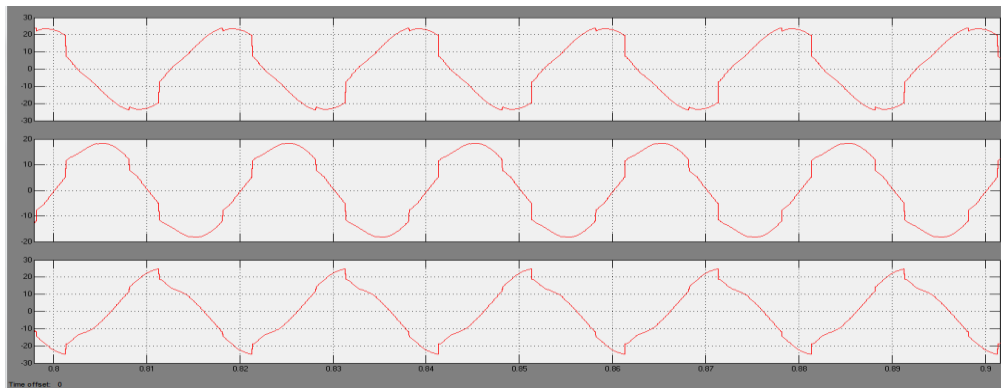

(b)

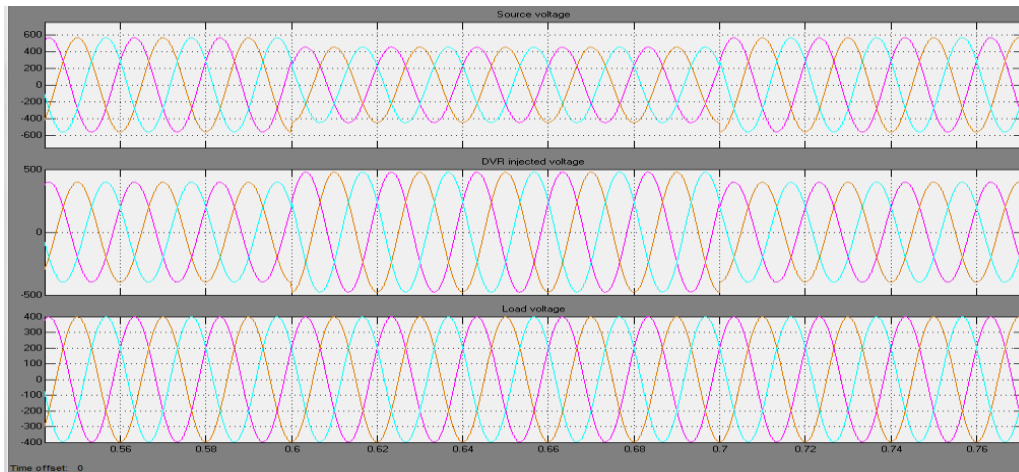

(c)

Figure 7 (a) Source currents of conventional topology, (b) Shunt Active Filter Currents, (c) Simulation results for compensation of voltage sag

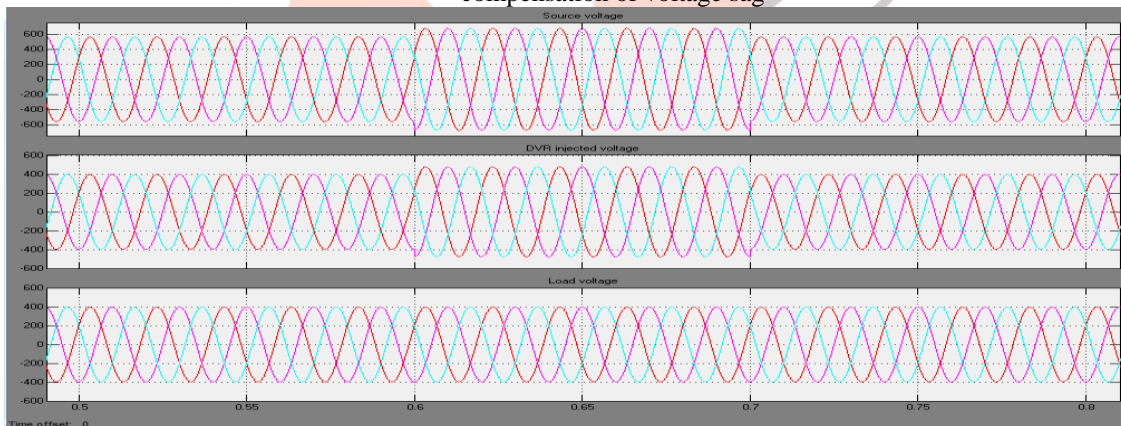

(d)

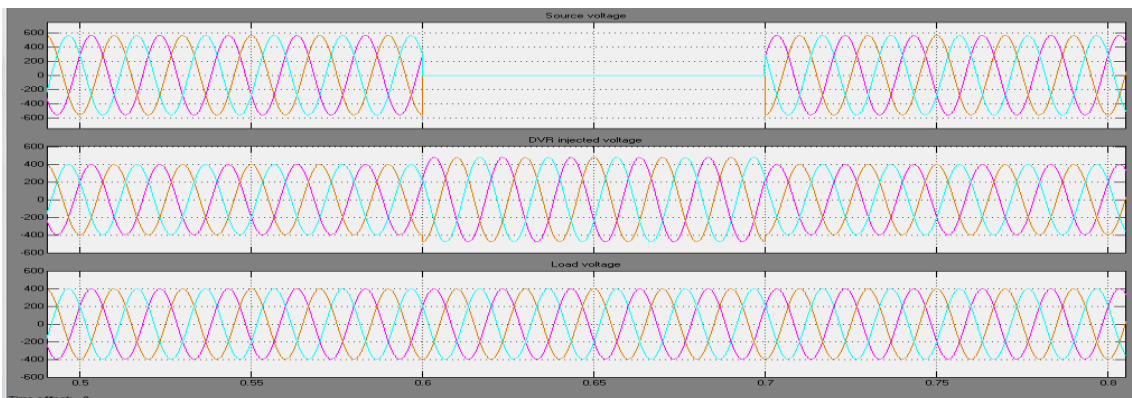

(e)

Figure 8 (d) Simulation results for compensation of voltage swell, (e) Simulation results for compensation of interruption



Output waveforms with modified topology  
x-time; y-voltage

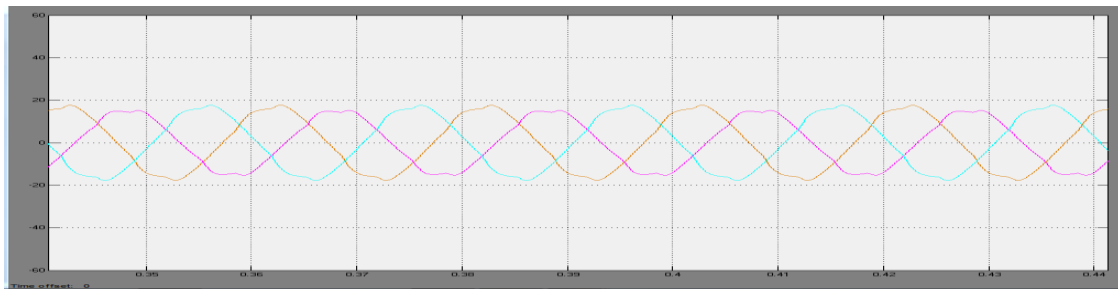

(f)

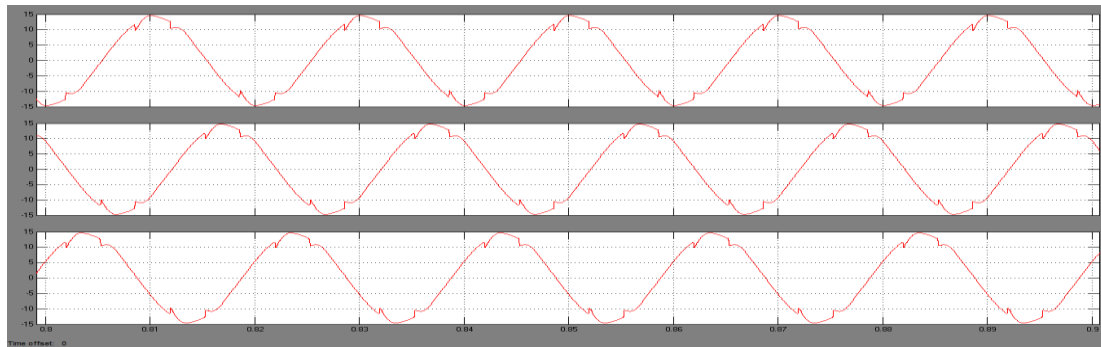

(g)

Figure 9 (f) Source currents (g) shunt active filter currents

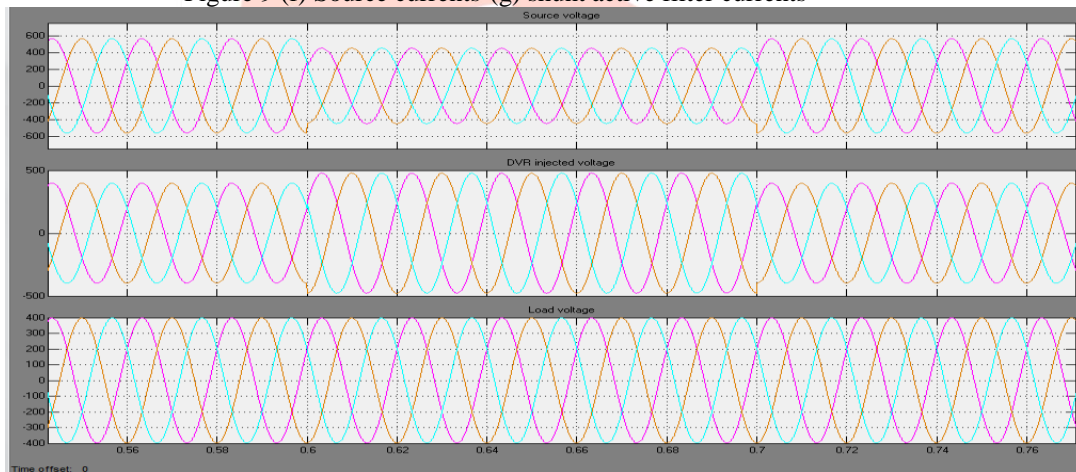

(h)

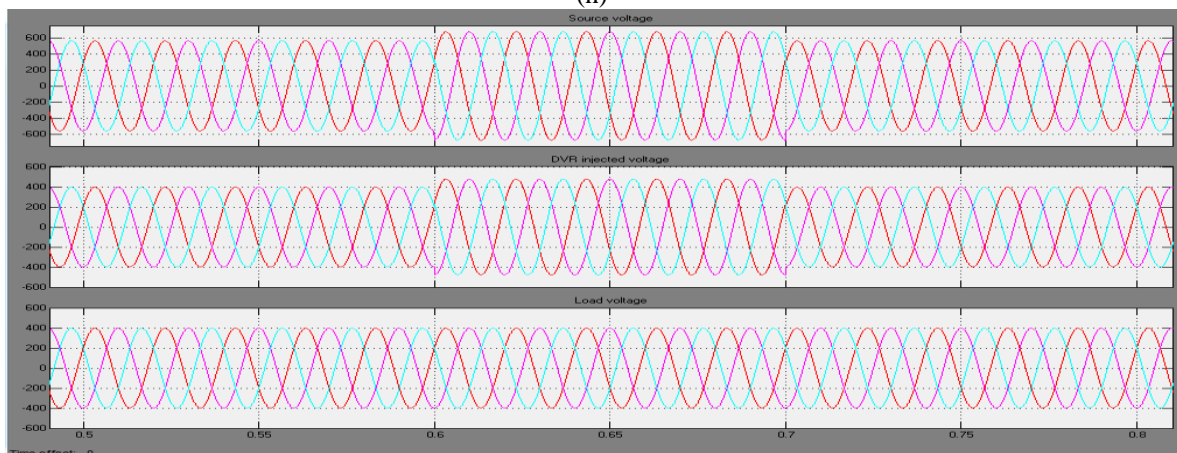

(i)

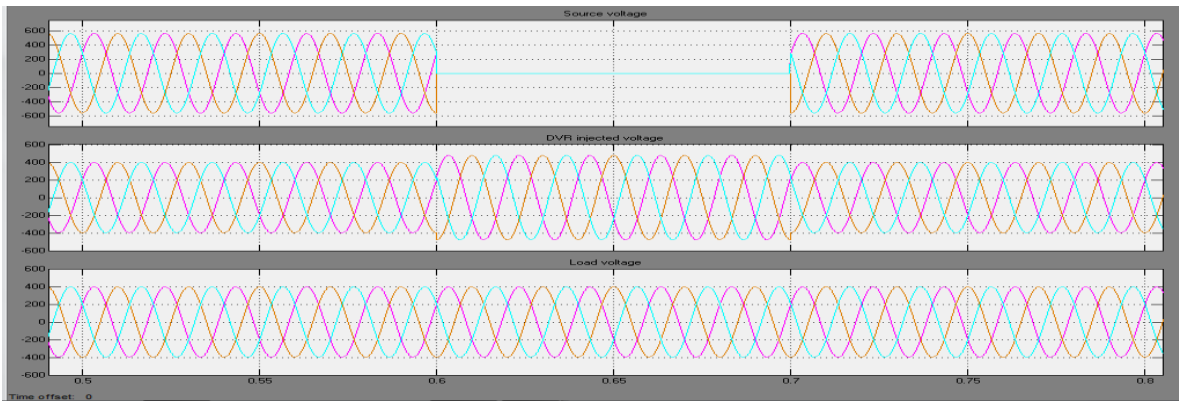

(j)

Figure 10 (h) Simulation results for compensation of voltage sag, (i) Simulation results for compensation of voltage swell, (j) Simulation results for compensation of interruption

**Harmonic analysis without compensation**

For the power distribution system without and with UPQC compensation the FFT analysis is carried out and Total Harmonic Distortion (THD) is found to be 12.38% and 7.63% and is shown below in Fig. 11.

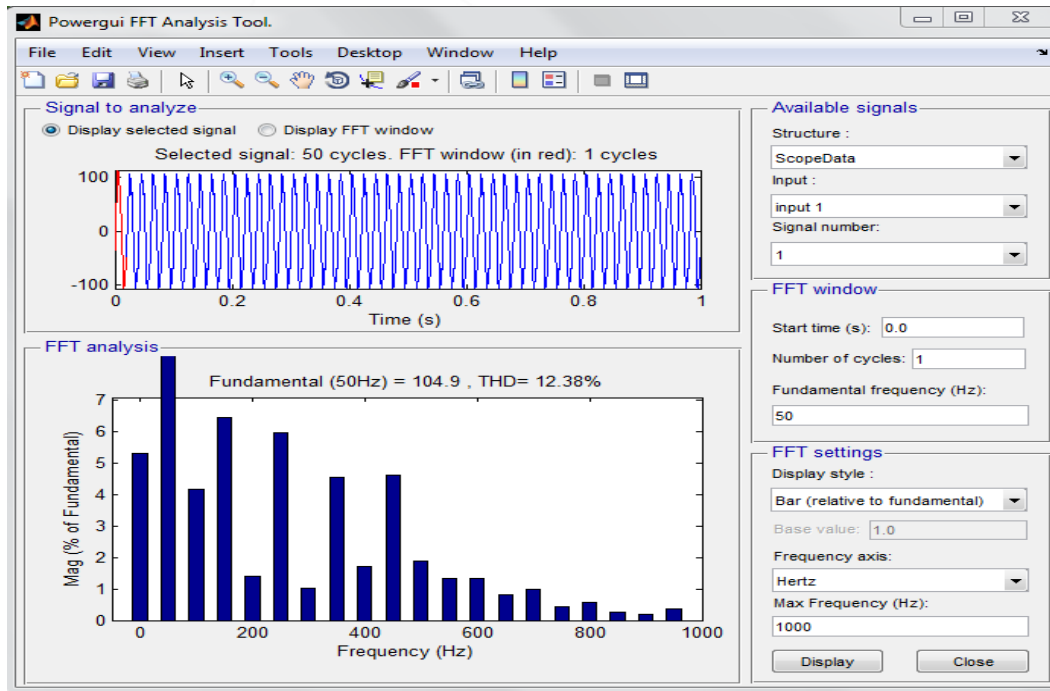

(k)

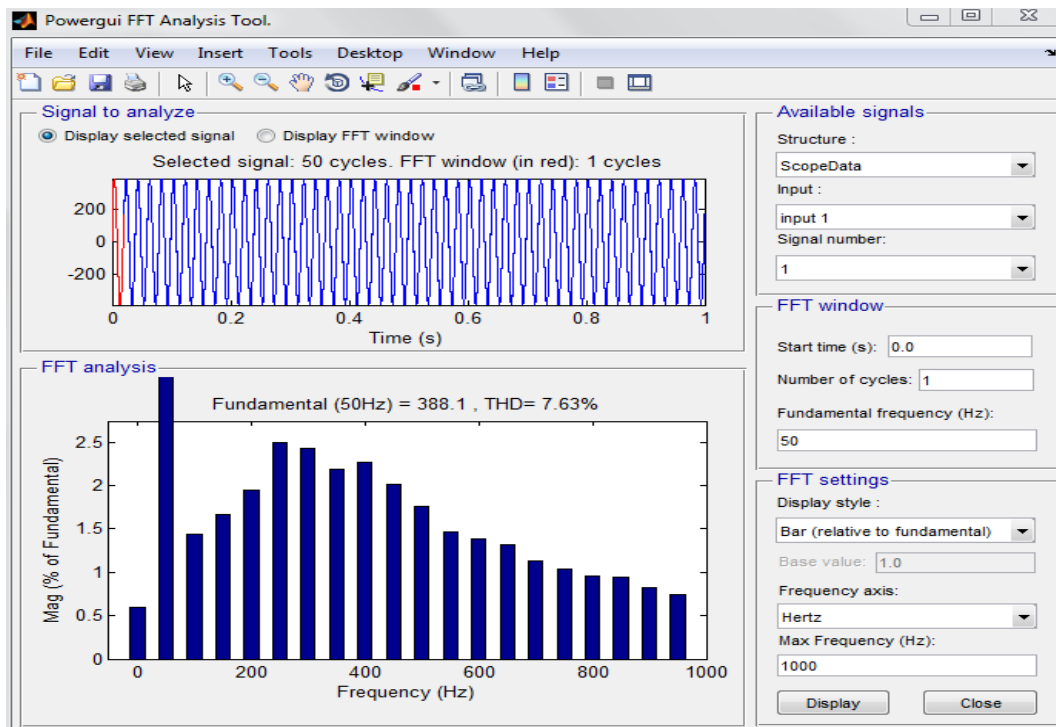

(l)

Figure 11 (k) Harmonic analysis without compensation, (l) Harmonic analysis with compensation

## VI. ACKNOWLEDGMENT

I have a great pleasure in expressing my deep sense of gratitude to Dr. Sidheshwar Prasad, Professor, Dept. of Electrical and Electronics Engineering, The Oxford college of Engineering, Bangalore for his willing consent, guidance and appreciation throughout my work. I am deeply grateful to my **Parents** who have been supportive with their tolerance and genuine inspiration, in equal parts.

## REFERENCES

- [1] M. Bollen, *Understanding Power Quality Problems: Voltage Sags and Interruptions*. New York: IEEE Press, 1999.
- [2] S. V. R. Kumar and S. S. Nagaraju, "Simulation of DSTATCOM and DVR in power systems," *ARPN J. Eng. Appl. Sci.*, vol. 2, no. 3, pp. 7–13, Jun. 2007.
- [3] B. T. Ooi, J. C. Salmon, J. W. Dixon, and A. B. Kulkarni, "A three-phase controlled-current PWM converter with leading power factor," *IEEE Trans. Ind. Appl.*, vol. IA-23, no. 1, pp. 78–84, Jan. 1987.
- [4] Y. Ye, M. Kazerani, and V. Quintana, "Modeling, control and implementation of three-phase PWM converters," *IEEE Trans. Power Electron.*, vol. 18, no. 3, pp. 857–864, May 2003.
- [5] R. Gupta, A. Ghosh, and A. Joshi, "Multiband hysteresis modulation and switching characterization for sliding-mode-controlled cascaded multi-level inverter," *IEEE Trans. Ind. Electron.*, vol. 57, no. 7, pp. 2344–2353, Jul. 2010.
- [6] S. Srikanthan and M. K. Mishra, "DC capacitor voltage equalization in neutral clamped inverters for DSTATCOM application," *IEEE Trans. Ind. Electron.*, vol. 57, no. 8, pp. 2768–2775, Aug. 2010.
- [7] R. Gupta, A. Ghosh, and A. Joshi, "Switching characterization of cascaded multilevel-inverter-controlled systems," *IEEE Trans. Ind. Electron.*, vol. 55, no. 3, pp. 1047–1058, Mar. 2008.
- [8] B. Singh and J. Solanki, "Load compensation for diesel generator-based isolated generation system employing DSTATCOM," *IEEE Trans. Ind. Electron.*, vol. 47, no. 1, pp. 238–244, Jan./Feb. 2011.
- [9] R. Gupta, A. Ghosh, and A. Joshi, "Characteristic analysis for multisampled digital implementation of fixed-switching-frequency closed-loop modulation of voltage-source inverter," *IEEE Trans. Ind. Electron.*, vol. 56, no. 7, pp. 2382–2392, Jul. 2009.
- [10] B. Singh and J. Solanki, "A comparison of control algorithms for DSTATCOM," *IEEE Trans. Ind. Electron.*, vol. 56, no. 7, pp. 2738–2745, Jul. 2009.
- [11] S. Rahmani, N. Mendalek, and K. Al-Haddad, "Experimental design of a nonlinear control technique for three-phase shunt active power filter," *IEEE Trans. Ind. Electron.*, vol. 57, no. 10, pp. 3364–3375, Oct. 2010.
- [12] V. Corasaniti, M. Barbieri, P. Arnera, and M. Valla, "Hybrid active filter for reactive and harmonics compensation in a distribution network," *IEEE Trans. Ind. Electron.*, vol. 56, no. 3, pp. 670–677, Mar. 2009.
- [13] M. Milane Montero, E. Romero-Cadaval, and F. Barrero-Gonzalez, "Hybrid multi converter conditioner topology for high-power applications," *IEEE Trans. Ind. Electron.*, vol. 58, no. 6, pp. 2283–2292, Jun. 2011.
- [14] J. Nielsen, M. Newman, H. Nielsen, and F. Blaabjerg, "Control and testing of a dynamic voltage restorer (DVR) at medium voltage level," *IEEE Trans. Power Electron.*, vol. 19, no. 3, pp. 806–813, May 2004.
- [15] Y. W. Li, P. C. Loh, F. Blaabjerg, and D. Vilathgamuwa, "Investigation and improvement of transient response of DVR at medium voltage level," *IEEE Trans. Ind. Appl.*, vol. 43, no. 5, pp. 1309–1319, Sep./Oct. 2007.

- [16] Y. W. Li, D. Mahinda Vilathgamuwa, F. Blaabjerg, and P. C. Loh, "A robust control scheme for medium-voltage-level DVR implementation," IEEE Trans. Ind. Electron., vol.54, no.4, pp.2249–2261, Aug.2007.
- [17] J. Barros and J. Silva, "Multilevel optimal predictive dynamic voltage restorer," IEEE Trans. Ind. Electron., vol.57, no.8, pp.2747–2760, Aug. 2010.
- [18] D. Vilathgamuwa, H. Wijekoon, and S. Choi, "A novel technique to compensate voltage sags in multilane distribution system—The interline dynamic voltage restorer," IEEE Trans. Ind. Electron., vol.53, no.5, pp. 1603–1611, Oct. 2006.
- [19] M. Kesler and E. Ozdemir, "Synchronous-reference-frame-based control method for UPQC under unbalanced and distorted load conditions," IEEE Trans. Ind. Electron., vol.58, no.9, pp.3967–3975, Sep.2011.
- [20] FACTS controllers in Power Transmission and Distribution, K. R. Padiyar
- [21] Understanding FACTS, Narain G. Hingorani Laszlo Gyugyi

