

# Design and Structural Analysis of Delta Wing Payloads of Light Combat Aircraft (TEJAS)

<sup>1</sup>shaik shama sultana, <sup>2</sup>Y.N.V.Santosh Kumar, <sup>3</sup>Shaik Azmatullah Rahaman

<sup>1</sup>Post Graduate Student, <sup>2</sup>Assistant Professor (Head of the Department), <sup>3</sup>Post Graduate Student,  
Department of Aerospace Engineering, Nimra Institute of Science and Technology, Ibrahimpatnam-521456, India.

**Abstract** - Now a days, In such advanced world where the technology has tremendously increased. need of aircrafts in the field of defense aviation has increased a lot which lead to the development of the light combat fighter aircrafts. This concept let us to design and analyze the delta wing payloads of tailless compound delta-wing indigenous 4th generation aircraft (TEJAS). It includes design of supersonic delta wing with customized airfoil according to the aircraft performance requirements, and integrates technologies such as relaxed static stability, fly-by-wire flight control system, multi-mode radar, integrated digital avionics system, composite material structures, and a flat rated engine. It is supersonic and highly maneuverable, and is the smallest and lightest in its class of contemporary combat aircraft. The delta wing structure is designed using catia software, which includes payloads such as drop tanks and missiles. Meshing is done in hyper mesh and static analyses of the delta wing payloads by including weights in different cases are analyzed.

**Key Words** - Computer Aided Three-Dimensional Interactive Application, hyper mesh and static analyses

## I. INTRODUCTION

The HAL (Hindustan Aeronautics limited) Tejas is a 4th generation multirole light fighter developed by India. It is a tailless compound delta-wing design powered by a single engine. It came from the Light Combat Aircraft (LCA) programme, which began in the 1980s to replace India's ageing MiG-21 fighters. Later, the LCA was officially named "Tejas meaning "Radiance".

The Tejas is the second supersonic fighter developed indigenously by Hindustan Aeronautics Limited (HAL) after the HAL Marut. It has a pure delta wing configuration, with no tail planes or fore planes, and a single dorsal fin. It integrates technologies such as relaxed static stability, fly-by-wire flight control system, multi-mode radar, integrated digital avionics system, composite material structures, and a flat rated engine. It is supersonic and highly maneuverable, and is the smallest and lightest in its class of contemporary combat aircraft.

The LCA programme's other main objective was to serve as the vehicle for an across-the-board advancement of India's domestic aerospace industry. The value of the aerospace "self-reliance" initiative is not simply the production of an aircraft, but also the building of a local industry capable of creating state-of-the-art products with commercial spin-offs for a global market. The LCA program was intended in part to further expand and advance India's indigenous aerospace capabilities.

The three most sophisticated and hence most challenging systems: the fly-by-wire (FBW) flight control system The Indian government's "self-reliance" goals for the LCA include indigenous development of (FCS), multi-mode pulse-Doppler radar, and afterburning turbofan engine.



Fig: 1 TEJAS aircraft

## II. EXPERIMENTAL DETAILS

### A. Design Methodology

Wing which is consisting of Drop Tanks & Missiles has been sketched in Catia, The delta wing design according to the dimensions given is drafted in the software catia where the delta wing is sketched and made in 3d. as shown in table-1, generated the delta wing as shown in figure 2.

Table 1 : AIRCRAFT AND WING SPECIFICATIONS

<b>Wing Span</b>	<b>8.20 m</b>
<b>Wing Area</b>	32.4 m <sup>2</sup>
<b>Length</b>	13.2 m
<b>Height</b>	4.40 m
<b>Empty Weight</b>	5,500 kg
<b>Loaded Weight</b>	8,500 kg
<b>Max: take-off weight</b>	>2,500 kg
<b>Max: Mach number</b>	1.8
<b>Service Ceiling</b>	15,000 m
<b>Composite Materials</b>	90% by area 45% by weight
<b>Missile Stations</b>	8 (1 in front fuselage, 4 in wings, 3 near to centre fuselage)
<b>Fuel Capacity</b>	5,00 kg in wings and fuselage tanks & 3,500 kg in external drop tanks

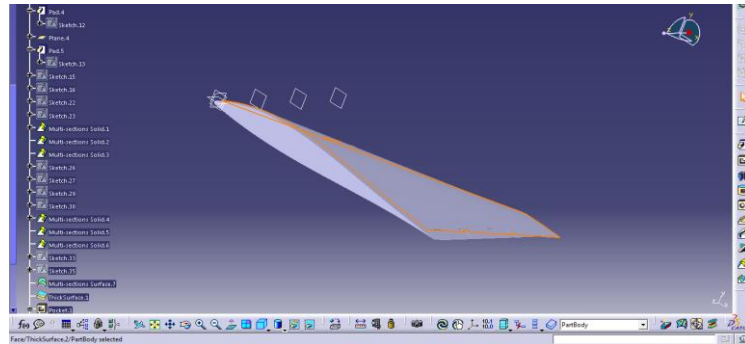

Figure 2: Delta wing sketching in catia

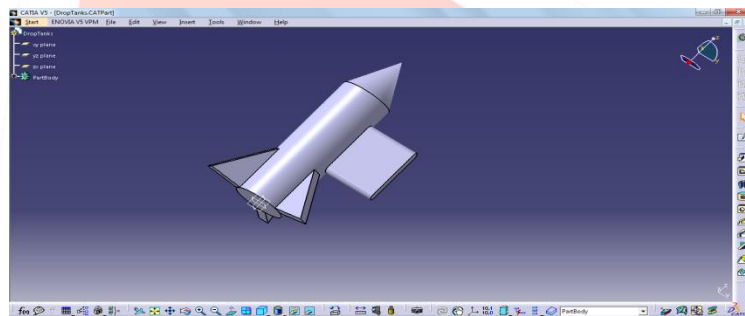

Figure 3: Model of Missile

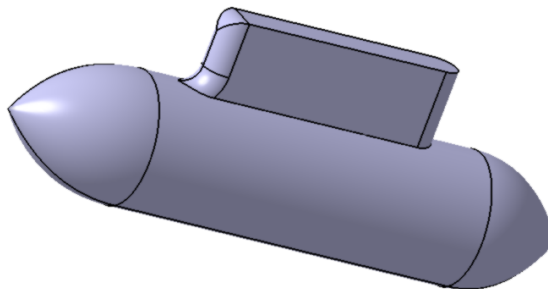

Figure 4: Model of Fuel drop Tank

### III. ASSEMBLY OF THE MAJOR COMPONENTS

After designing the major components assembly to the wing is done

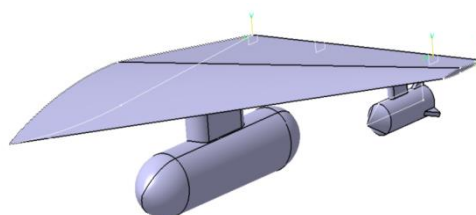

Figure 5 : Assembled Delta Wing with Pay Loads

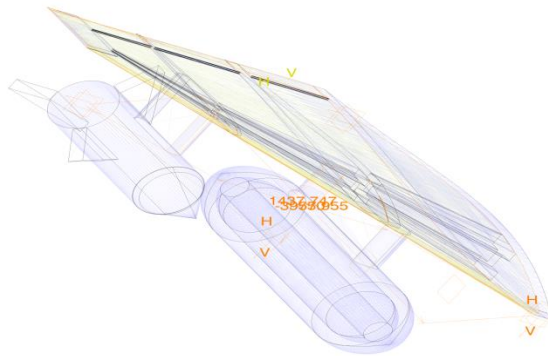

Figure 6 : Structural View of Assembled Delta Wing

**B. Analysis of Different Payloads**

Analysis is done on the wing by taking the load constraints.

**Importing The Wing Model**

The designed wing is imported to “HYPER MESH” and meshing is done. And the model is imported to ANSYS software.

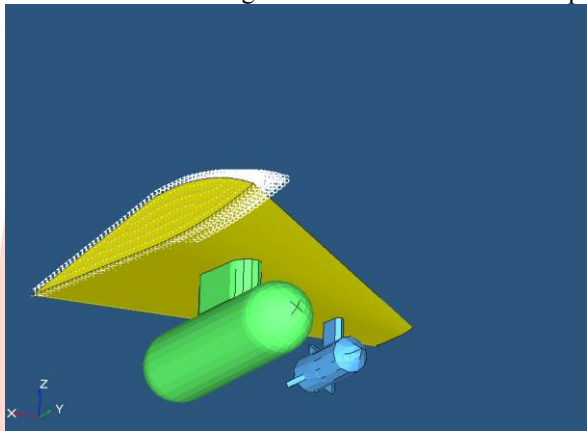

Figure 7: Hyper mesh Imported

**Meshing**

Meshing is done with the tetrahedral elements on the wing.

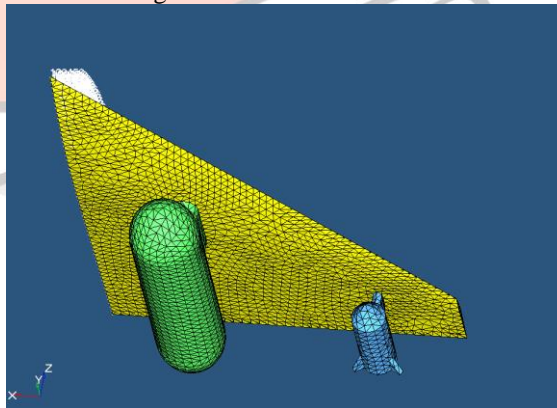

Figure 8: Meshed Model

**Materials Properties**

After completing meshing Material properties are defined to the model. The Material Chosen was Carbon fiber with high young’s Modulus and Density.

- Young’s Modulus EX = >300 Gpa
- Poisson’s ratio PRXY = 0.3
- Density =1750 kg/ m<sup>3</sup>

Defining material properties to rockets and fuel tank.

- Young’s Modulus EX = 100 Gpa
- Poisson’s ratio PRXY = 0.3
- Density =1013 kg/ m<sup>3</sup>

### Creating 3-D Solid Elements

After representing the material properties and defining the values we are creating the 3-d solid elements in tetrahedral elements. Which is defined as the solid- 45.

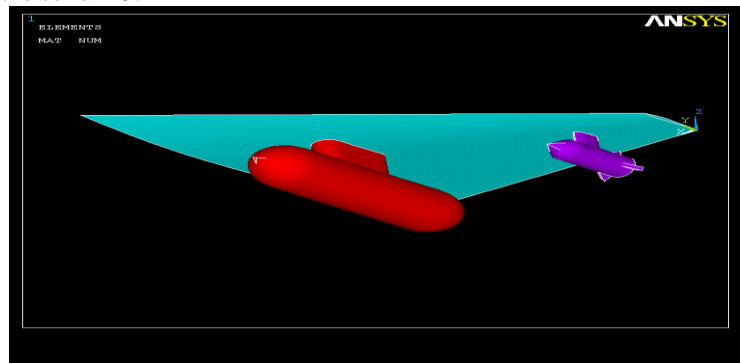

Figure 9: Defined 3D Elements

### Constraints

In this process after defining the solid elements the constraints are fixed i.e the wing is fixed from one end.

Finally the file is saved in the .CDB file format which can imported and read easily by ansys software. Then the analysis process is done in the ansys software where the different payloads are applied to the wing model to obtained minimum and maximum displacement and stress minimum and maximum.

### Analysis and Applying Loads

Before importing the meshing file there is a Toggle Checks is to be done. In order to Check the shape of elements the ansys software reads the file and opens it.

- Preprocessor
  - Checking controls
  - Toggle checks
  - Define the file.

The ansys software read the files to find any shaped element errors. If no errors are found the model is finally displayed in a new window.

### Applying the Loads

As the model is imported in the ansys we can directly apply the loads and solved.

- Preprocessor
  - Loads
  - Define loads
  - Apply
  - Structural
  - Inertial
  - Gravity
  - Global

Fuel tank and missile Loads are defined.

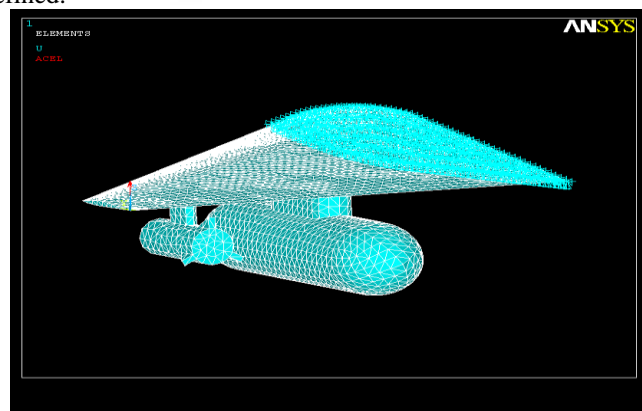

Figure 10: Applying Loads

### CASE 1

In this case, there is no payloads to the wing i.e. fuel tank and missile.

- Solution
  - Solve
  - Current Ls.

– Solution is done.

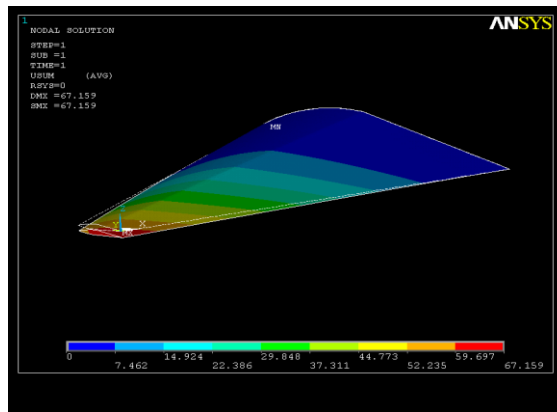

Figure 11: Displacement

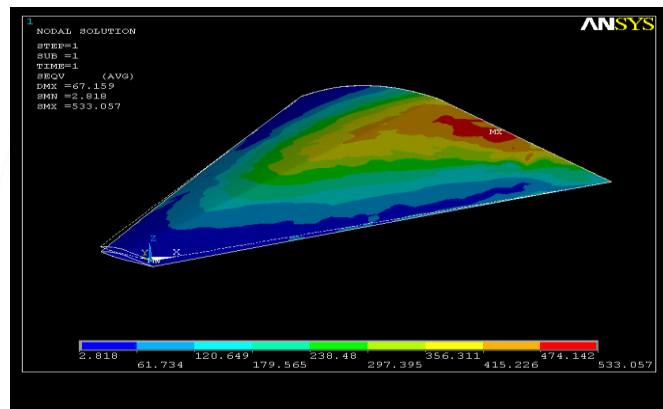

Figure 12: Stress

Displacement of wing tip due to bending by its own gravity minimum is 7.462mm and maximum 67.159mm. Minimum Stress obtained is 2.818 N/m<sup>2</sup> maximum Stress is obtained at the fixed end i.e. 533.057 N/m<sup>2</sup>

**IV. RESULTS**

- Static analysis is done when the aircraft is grounded at different payloads conditions.
- When the aircraft is on ground without any payload under wings.
- 140 kg empty fuel tank is attached to the wing without any missile, then fuel is filled half tank which is 800 kg and missile is also attached whose weight is 146 kg, finally fuel tank is fully filled whose weight is 1400 kg and missile is also present. These cases have been analyzed and results are shown.
- Delta wing without any payloads
  - Displacement: Minimum = 7.462mm, Maximum = 67.159mm.
  - Stress: Minimum = 2.818 N/m<sup>2</sup>, Maximum = 533.057 N/m<sup>2</sup>
- With empty fuel tank and no missile
  - Displacement: Minimum = 7.153mm, Maximum = 64.373mm
  - Stress: Minimum = 0.030 N/m<sup>2</sup>, Maximum = 602.099 N/m<sup>2</sup>
- Half filled fuel tank and missile attached.
  - Displacement: Minimum = 8.939mm, Maximum = 80.454mm
  - Stress: Minimum = 0.179 N/m<sup>2</sup>, Maximum = 694.172 N/m<sup>2</sup>
- Fully filled fuel tank and missile attached
  - Displacement: Minimum = 9.242mm, Maximum = 83.179mm
  - Stress: Minimum = 0.1756 N/m<sup>2</sup>, Maximum = 741.792 N/m<sup>2</sup>

Table 2: ITERATION OF WEIGHTS

S NO	CASE	PAYLOAD FUE TANK	MISSILE	DISPLACEMENT MAX	STRESS MAX
1	CASE 1	0	0	67.159 mm	533.057 N/m <sup>2</sup>
2	CASE 2	140 kg	0	64.373 mm	602.099 N/m <sup>2</sup>
3	CASE 3	800 kg	146 kg	80.454 mm	694.172 N/m <sup>2</sup>
4	CASE 4	1400 kg	146 kg	83.179 mm	741.792 N/m <sup>2</sup>

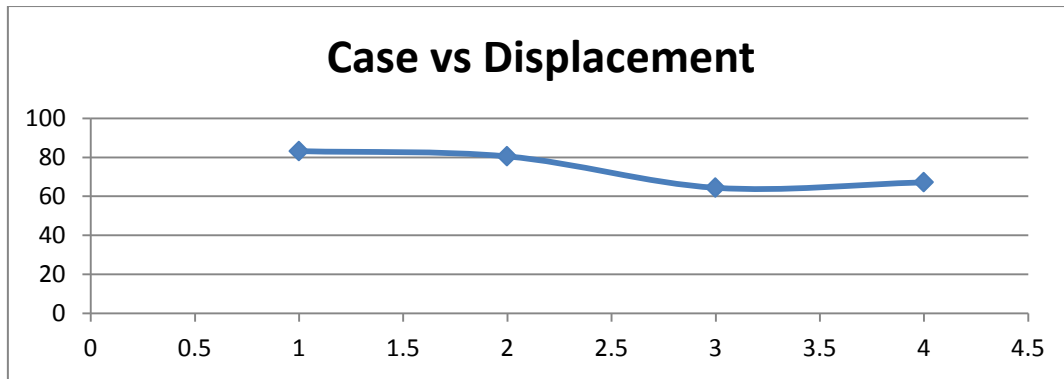

Graph 1 Case vs Displacement

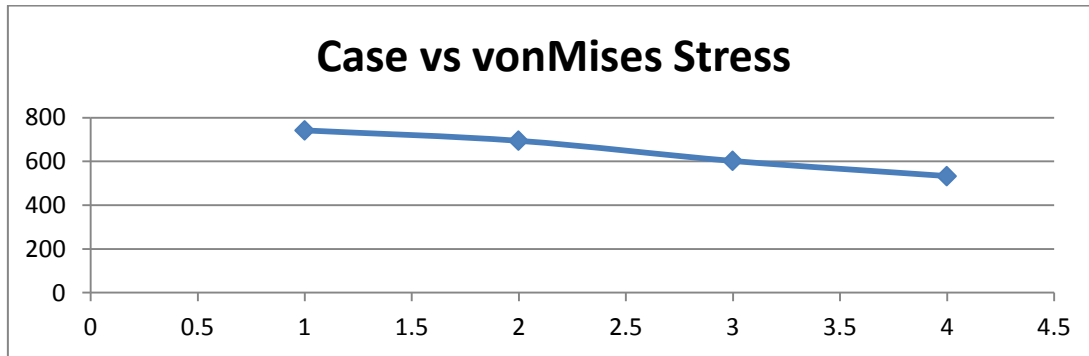

Graph 2 Case vs Stress

The above two graphs shows about the displacements and stress curves with respective to the payloads applied.

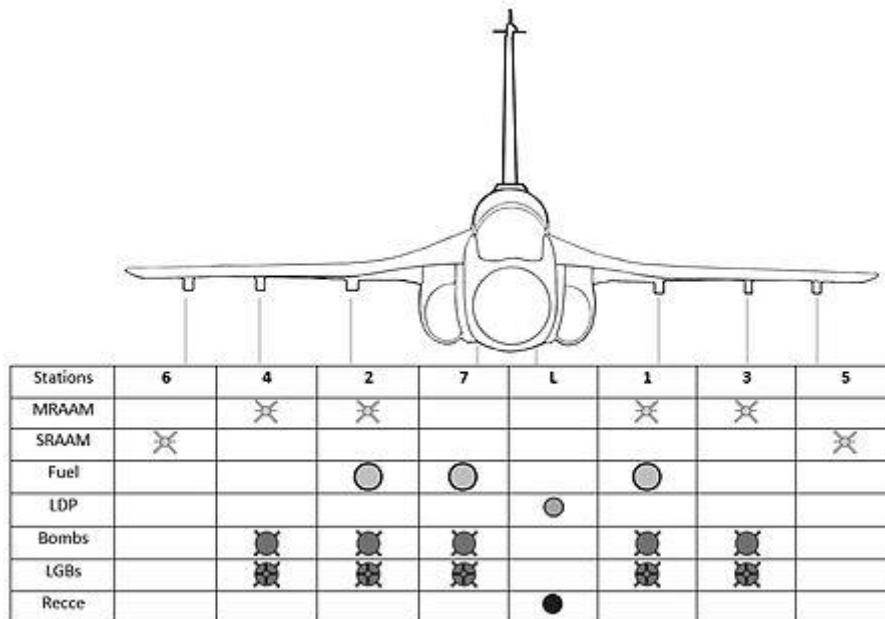

**SPECIFICATIONS (HAL TEJAS MK.1)**

Weapon stations on Tejas

Data from tejas.gov.in DRDO Tech focus, Aero India 2011

**General characteristics**

- Crew: 1
- Length: 13.20 m (43 ft 4 in)
- Wingspan: 8.20 m (26 ft 11 in)
- Height: 4.40 m (14 ft 9 in)
- Wing area: 38.4 m<sup>2</sup> (413 ft<sup>2</sup>)
- Empty weight: 6,500 kg (14,300 lb)
- Loaded weight: 9,500 kg (20,944 lb)
- **Wing payloads : 1330 kg (2932.148 lb)**



- Max. takeoff weight: 13,200 kg (29,100 lb)
- Power plant: 1 × F404-GE-IN20 turbofan
  - Dry thrust: 53.9 kN (12,100 lbf)
  - Thrust with afterburner: 89.8 kN (20,200 lbf)
- Internal fuel capacity: 2,458 kg
- External fuel capacity: 2 x 1,200 litre drop tank at inboard, 1 x 725-litre drop tank under fuselage

#### Performance

- Maximum speed: Tested up to Mach 1.6 (1,350 km/h) (CAS) at high altitude
- Range: 850 km (459 nmi, 528 mi)
- Combat radius: 300 km (162 nmi, 186 mi)
- Ferry range: 3,000 km (1,840 mi)
- Service ceiling: 15,000 m (49,200 ft)
- Wing loading: 247 kg/m<sup>2</sup> (50.7 lb/ft<sup>2</sup>)
- Thrust/weight: 1.07
- g-limits: +8/-3.5 g

These are the given specifications of the Tejas mach 1 by HAL Bangalore

#### V. CONCLUSION

1. The light features of Tejas aircraft is studied with
  - Overview
  - Airframe
  - Flight controls
  - Propulsion
  - Avionics
  - Radar and sensors
  - Self-protection
2. The new Delta wing is modeled in Catia.
3. The wing which is consisting of Drop Tanks & Missiles has been sketched in Catia, 3-D meshing is done in hyper Mesh and analyzed in Ansys software.
4. 1330kg payload including fuel tank and missile which is barred by TEJAS aircraft And 1546kg payload is also suitable with minimum displacements and stresses Which are analyzed in static position.
5. By considering the above aspects, the wing which we designed Bares more payload compare to the LCA-Delta wing (TEJAS).

#### VI. REFERENCES

- [1] City central library, HAL bengaluru.
- [2] Hal Tejas aircraft Manual.
- [3] Guan, Jingling; Sritharan, SS (2008). "A Problem of Hyperbolic-Elliptic Type Conservation Laws on Manifolds that Arises in Delta-Wing Aerodynamics".
- [4] Sritharan, SS (1985). "Delta Wings with Shock-Free Cross Flow". *Quarterly of Applied Mathematics*. XLIII: 275–86.
- [5] Website: [www.tejas.gov.in/](http://www.tejas.gov.in/).
- [6] <https://www.defenseindustrydaily.com/india-lca-tejas>
- [7] Jackson, Paul, Kenneth Munson and Lindsay Peacock, eds. "ADA Tejas." *Jane's All The World's Aircraft 2005–06*. Coulsdon, Surrey, UK: Jane's Information Group Limited, 2005. ISBN 0-7106-2684-3.
- [8] Taylor, John W. R., Kenneth Munson and Michael J. H. Taylor, eds. "HAL Light Combat Aircraft." *Jane's All The World's Aircraft 1989–1990*. Coulsdon, Surrey, UK: Jane's Information Group Limited, 2005. ISBN 0-7106-0896-9.